

USER MANUAL

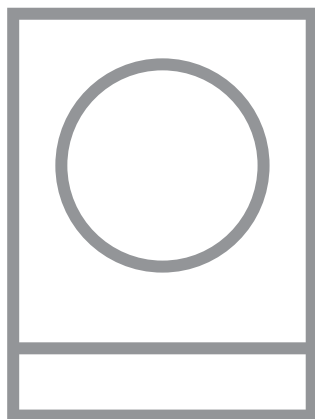

FOR PERFECT RESULTS

Thank you for choosing this AEG product. We have created it to give you impeccable performance for many years, with innovative technologies that help make life simpler – features you might not find on ordinary appliances. Please spend a few minutes reading to get the very best from it.

Visit our website to:



Get usage advice, brochures, trouble shooter, service and repair information:
www.aeg.com/support



Register your product for better service:
www.registeraeg.com



Buy Accessories, Consumables and Original spare parts for your appliance:
www.aeg.com/shop

CUSTOMER CARE AND SERVICE

Always use original spare parts.

When contacting our Authorised Service Centre, ensure that you have the following data available: Model, PNC, Serial Number.

The information can be found on the rating plate.

 Warning / Caution-Safety information

 General information and tips

 Environmental information

Subject to change without notice.

CONTENTS

1. SAFETY INFORMATION.....	2
2. SAFETY INSTRUCTIONS.....	4
3. INSTALLATION.....	7
4. PRODUCT DESCRIPTION.....	10
5. DAILY USE.....	11
6. HINTS AND TIPS.....	14
7. CARE AND CLEANING.....	16
8. TROUBLESHOOTING.....	17
9. TECHNICAL DATA.....	18
10. ENVIRONMENTAL CONCERNS.....	18

1. SAFETY INFORMATION

Before the installation and use of the appliance, carefully read the supplied instructions. The manufacturer is not responsible for any injuries or damage that are the result of incorrect

installation or usage. Always keep the instructions in a safe and accessible location for future reference.

1.1 Children and vulnerable people safety

- This appliance can be used by children aged from 8 years and above and persons with reduced physical, sensory or mental capabilities or lack of experience and knowledge if they have been given supervision or instruction concerning the use of the appliance in a safe way and understand the hazards involved. Children of less than 8 years of age and persons with very extensive and complex disabilities shall be kept away from the appliance unless continuously supervised.
- Children should be supervised to ensure that they do not play with the appliance.
- Keep all packaging away from children and dispose of it appropriately.
- **WARNING:** Keep children and pets away from the appliance when it operates or when it cools down. Accessible parts become hot during use.
- If the appliance has a child safety device, it should be activated.
- Children shall not carry out cleaning and user maintenance of the appliance without supervision.

1.2 General Safety

- **WARNING:** The appliance and its accessible parts become hot during use. Care should be taken to avoid touching heating elements.
- **WARNING:** Unattended cooking on a hob with fat or oil can be dangerous and may result in fire.
- Never use water to extinguish the cooking fire. Switch off the appliance and cover flames with e.g. a fire blanket or lid.
- **WARNING:** The appliance must not be supplied through an external switching device, such as a timer, or connected to a circuit that is regularly switched on and off by a utility.

- **CAUTION:** The cooking process has to be supervised. A short term cooking process has to be supervised continuously.
- **WARNING:** Danger of fire: Do not store items on the cooking surfaces.
- Metallic objects such as knives, forks, spoons and lids should not be placed on the hob surface since they can get hot.
- Do not use the appliance before installing it in the built-in structure.
- Do not use a steam cleaner to clean the appliance.
- After use, switch off the hob element by its control and do not rely on the pan detector.
- If the glass ceramic surface / glass surface is cracked, switch off the appliance and unplug it from the mains. In case the appliance is connected to the mains directly using junction box, remove the fuse to disconnect the appliance from power supply. In either case contact the Authorised Service Centre.
- If the supply cord is damaged, it must be replaced by the manufacturer, an authorized Service or similarly qualified persons in order to avoid a hazard.
- **WARNING:** Use only hob guards designed by the manufacturer of the cooking appliance or indicated by the manufacturer of the appliance in the instructions for use as suitable or hob guards incorporated in the appliance. The use of inappropriate guards can cause accidents.

2. SAFETY INSTRUCTIONS

2.1 Installation



WARNING!

Only a qualified person must install this appliance.



WARNING!

Risk of injury or damage to the appliance.

- Remove all the packaging.
- Do not install or use a damaged appliance.
- Follow the installation instructions supplied with the appliance.
- Keep the minimum distance from other appliances and units.
- Always take care when moving the appliance as it is heavy. Always use safety gloves and enclosed footwear.

- Seal the cut surfaces with a sealant to prevent moisture from causing swelling.
- Protect the bottom of the appliance from steam and moisture.
- Do not install the appliance next to a door or under a window. This prevents hot cookware from falling from the appliance when the door or the window is opened.
- If the appliance is installed above drawers make sure that the space, between the bottom of the appliance and the upper drawer is sufficient for air circulation.
- The bottom of the appliance can get hot. Make sure to install a separation panel made from plywood, kitchen carcass material or other non-flammable materials under the appliance to prevent access to the bottom.
- The separation panel has to cover the area under the hob completely.
- Make sure that the ventilation space of 2 mm, between the worktop and the front of the below unit, is free. The warranty does not cover damages caused by the lack of an adequate ventilation space.

2.2 Electrical Connection



WARNING!

Risk of fire and electric shock.

- All electrical connections should be made by a qualified electrician.
- The appliance must be earthed.
- Before carrying out any operation make sure that the appliance is disconnected from the power supply.
- Make sure that the parameters on the rating plate are compatible with the electrical ratings of the mains power supply.
- Make sure the appliance is installed correctly. Loose and incorrect electricity mains cable or plug (if applicable) can make the terminal become too hot.
- Use the correct electricity mains cable.
- Do not let the electricity mains cable tangle.
- Make sure that a shock protection is installed.
- Use the strain relief clamp on the cable.
- Make sure the mains cable or plug (if applicable) does not touch the hot

appliance or hot cookware, when you connect the appliance to a socket.

- Do not use multi-plug adapters and extension cables.
- Make sure not to cause damage to the mains plug (if applicable) or to the mains cable. Contact our Authorised Service Centre or an electrician to change a damaged mains cable.
- The shock protection of live and insulated parts must be fastened in such a way that it cannot be removed without tools.
- Connect the mains plug to the mains socket only at the end of the installation. Make sure that there is access to the mains plug after the installation.
- If the mains socket is loose, do not connect the mains plug.
- Do not pull the mains cable to disconnect the appliance. Always pull the mains plug.
- Use only correct isolation devices: line protecting cut-outs, fuses (screw type fuses removed from the holder), earth leakage trips and contactors.
- The electrical installation must have an isolation device which lets you disconnect the appliance from the mains at all poles. The isolation device must have a contact opening width of minimum 3 mm.

2.3 Use



WARNING!

Risk of injury, burns and electric shock.

- Remove all the packaging, labelling and protective film (if applicable) before first use.
- This appliance is for household (indoors) use only.
- Do not change the specification of this appliance.
- Make sure that the ventilation openings are not blocked.
- Do not let the appliance stay unattended during operation.
- Set the cooking zone to “off” after each use.
- Do not put cutlery or saucepan lids on the cooking zones. They can become hot.
- Do not operate the appliance with wet hands or when it has contact with water.

- Do not use the appliance as a work surface or as a storage surface.
- If the surface of the appliance is cracked, disconnect immediately the appliance from the power supply. This to prevent an electrical shock.
- Users with a pacemaker must keep a distance of minimum 30 cm from the induction cooking zones when the appliance is in operation.
- When you place food into hot oil, it may splash.



WARNING!

Risk of fire and explosion

- Fats and oil when heated can release flammable vapours. Keep flames or heated objects away from fats and oils when you cook with them.
- The vapours that very hot oil releases can cause spontaneous combustion.
- Used oil, that can contain food remnants, can cause fire at a lower temperature than oil used for the first time.
- Do not put flammable products or items that are wet with flammable products in, near or on the appliance.



WARNING!

Risk of damage to the appliance.

- Do not keep hot cookware on the control panel.
- Do not put a hot pan cover on the glass surface of the hob.
- Do not let cookware boil dry.
- Be careful not to let objects or cookware fall on the appliance. The surface can be damaged.
- Do not activate the cooking zones with empty cookware or without cookware.
- Do not put aluminium foil on the appliance.
- Cookware made of cast iron, aluminium or with a damaged bottom can cause scratches on the glass / glass ceramic. Always lift these objects up when you have to move them on the cooking surface.

- This appliance is for cooking purposes only. It must not be used for other purposes, for example room heating.

2.4 Care and cleaning

- Clean the appliance regularly to prevent the deterioration of the surface material.
- Switch off the appliance and let it cool down before cleaning.
- Do not use water spray and steam to clean the appliance.
- Clean the appliance with a moist soft cloth. Use only neutral detergents. Do not use abrasive products, abrasive cleaning pads, solvents or metal objects.

2.5 Service

- To repair the appliance contact the Authorised Service Centre. Use original spare parts only.
- Concerning the lamp(s) inside this product and spare part lamps sold separately: These lamps are intended to withstand extreme physical conditions in household appliances, such as temperature, vibration, humidity, or are intended to signal information about the operational status of the appliance. They are not intended to be used in other applications and are not suitable for household room illumination.

2.6 Disposal



WARNING!

Risk of injury or suffocation.

- Contact your municipal authority for information on how to dispose of the appliance.
- Disconnect the appliance from the mains supply.
- Cut off the mains electrical cable close to the appliance and dispose of it.

3. INSTALLATION



WARNING!

Refer to Safety chapters.

3.1 Before the installation

Before you install the hob, write down the information below from the rating plate. The rating plate is on the bottom of the hob.

Serial number

3.2 Built-in hobs

Only use the built-in hobs after you assemble the hob into correct built-in units and work surfaces that align to the standards.

3.3 Connection cable

- The hob is supplied with a connection cable.
- To replace the damaged mains cable, use the cable type: H05V2V2-F which withstands a temperature of 90 °C or higher. Contact an Authorised Service Centre. The connection cable may only be replaced by a qualified electrician.

3.4 Attaching the seal - On-top installation

1. Clean the worktop around the cut out area.
2. Attach the supplied 2x6mm seal stripe to the lower edge of the hob, along the outer edge of the glass ceramic. Do not stretch it. Make sure that the ends of the seal stripe are located in the middle of one side of the hob.
3. Add some millimetres to the length when you cut the seal stripe.
4. Join the two ends of the seal stripe together.

3.5 Assembly

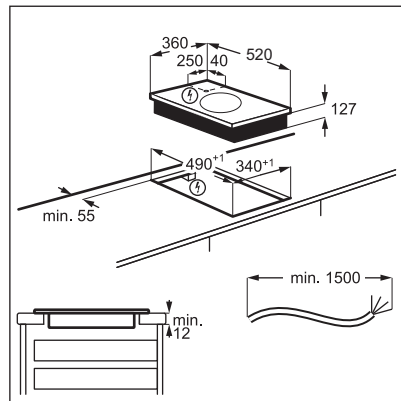
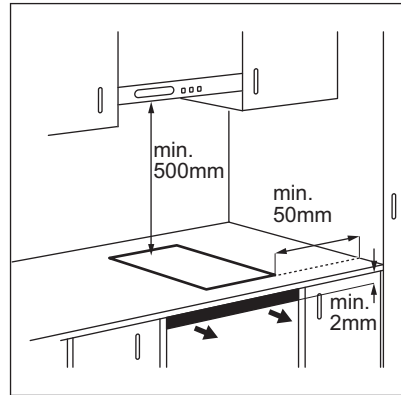

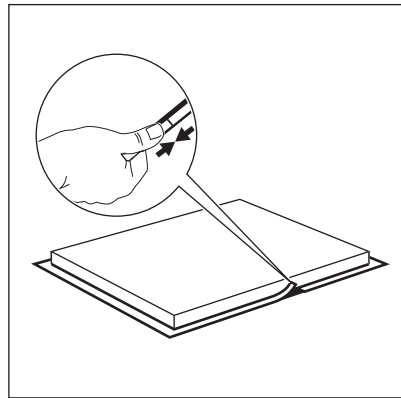
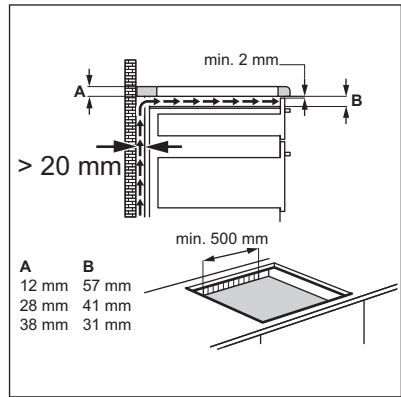
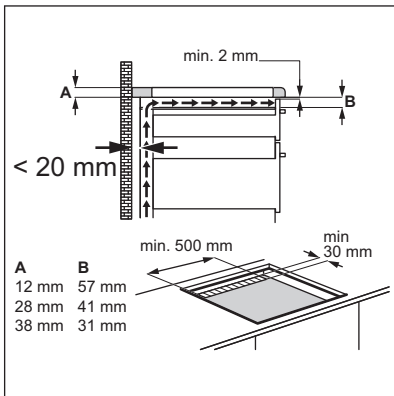
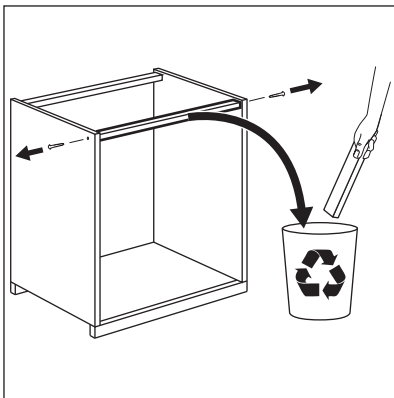
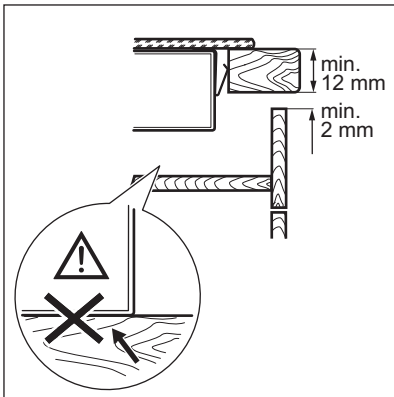

3.6 Installation of more than one hob

Supplied accessories: connection bar, heat-resistant silicone, rubber shape, sealing stripe.



Use only a special heat-resistant silicone.

The worktop cutout

Distance from the wall minimum 50 mm

Length 490 mm

Width the sum of all widths of appliances that you install minus 20 mm

Example:

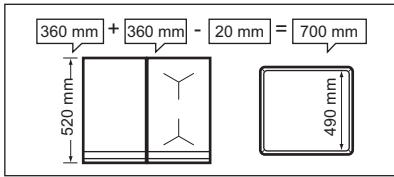

Assembly

- Calculate correct cutout dimensions.
- Prepare the worktop cutout.
- Place the appliances on a soft surface (e.g. a blanket) with the bottom side up.
- In the case of the Teppan Yaki, attach the supplied seal stripe to its lower edge, along the outer edge of the glass ceramic. Loosely screw the fixing plates into the correct holes in the protection casing.
- Insert the first appliance into the worktop cutout. Mount the connection bar under the appliance so that a half of its width is still visible - it will support the next appliance.

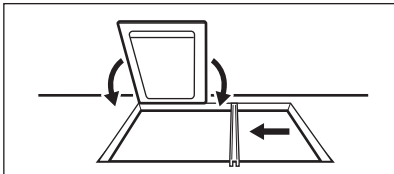

- For the Teppan Yaki, loosely screw in the fixing plates to the worktop from below (at the front and the rear of the appliance).

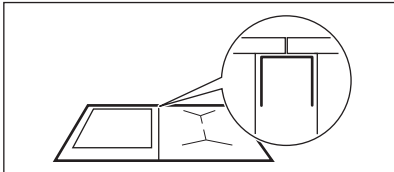

- Insert the next appliance into the worktop cutout. Make sure that the front edges of the appliances are on the same level.

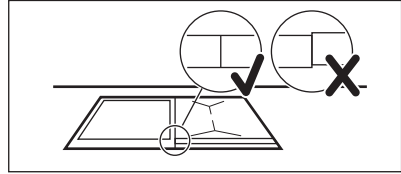

- Fix appliances other than Teppan Yaki with the use of snap-in springs.
- At the end, tighten the screws of the Teppan Yaki.

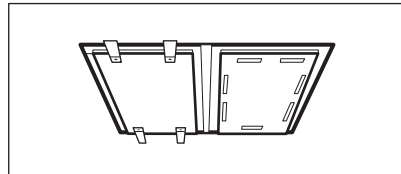

- Use silicone to seal the gaps between the appliances and those between the appliances and the worktop.
- Press the rubber shape firmly against the glass ceramic and move it slowly along the edges to squeeze out excess silicone.
- Put some soapy water on the silicone and smoothen out the edges with your finger.
- Do not touch the silicone until it hardens, it can last for about a day.
- Carefully remove the silicone squeeze-out with a shaving razor.
- Clean the glass surface.

4. PRODUCT DESCRIPTION

4.1 Cooking surface layout

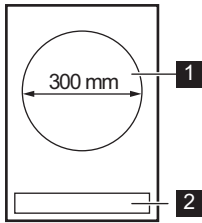

- 1** Induction cooking surface
- 2** Control panel

4.2 Control panel layout

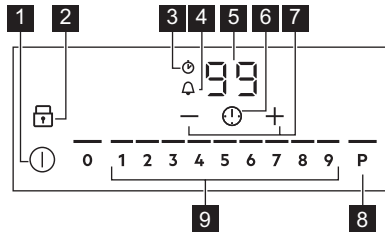

Use the sensor fields to operate the appliance. The displays, indicators and sounds tell which functions operate.

Sensor field	Comment
1	To activate and deactivate the hob.
2	To activate and deactivate Lock or Child Safety Device.
3	CountUp Timer indicator.
4	Count Down Timer indicator.
5 -	Timer display: 00 - 99 minutes.
6	To select Timer functions.
7	To increase and decrease the time.
8 P	To activate PowerBoost.
9 -	To set a heat setting: 0 - 9.

4.3 Accessories

The WOK pan P 6.0 (supplied)



Only use the supplied WOK pan.

390 mm, 6 litres, 1 handle, stainless steel.

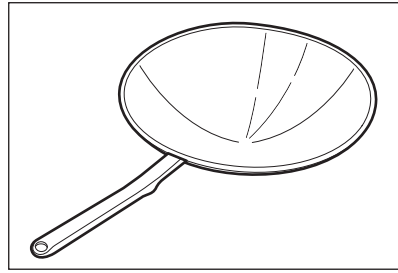

5. DAILY USE



WARNING!

Refer to Safety chapters.

5.1 Activating and deactivating

Touch  for 1 second to activate or deactivate the hob.

The control panel comes on after you activate the hob and goes off after you deactivate the hob.

5.2 Automatic Switch Off

The function deactivates the hob automatically if:

- you do not place any cookware on the hob for 50 seconds,
- you do not set the heat setting for 50 seconds after you place the cookware,
- you spill something or put something on the control panel for more than 10 seconds (a pan, a cloth). When you hear the acoustic signal, the hob deactivates. Remove the object or clean the control panel.
- the hob gets too hot (e.g. when a saucepan boils dry). Let the cooking zone cool down before you use the hob again.
- you do not deactivate a cooking zone or change the heat setting. After some time, the hob deactivates.

The relation between the heat setting and the time after which the hob deactivates:

Heat setting	The hob deactivates after
1 - 2	6 hours

Heat setting	The hob deactivates after
3 - 4	5 hours
5	4 hours
6 - 9	1.5 hours

5.3 Use of the wok

Put the wok pan into the wok cavity carefully. Do not shake the wok pan while it is in the wok cavity.



CAUTION!

Make sure the handle of the wok pan does not hit or scratch the surface of the hob. It can cause damage to the hob.

5.4 Heat setting

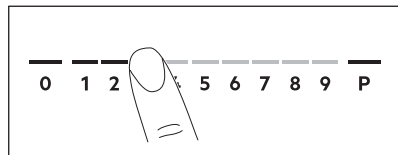

1. Press the desired heat setting on the control bar. You can also move your finger along the control bar to set or change the heat setting for a cooking zone.
2. To deactivate a cooking zone, press 0. Once you place a pot on the cooking zone and set the heat setting, it remains the same for 2 minutes after you remove the pot. If you

place the pot on the cooking zone again within this time, the heat setting reactivates. Otherwise the cooking zone deactivates.

5.5 PowerBoost

This function activates more power for the appropriate induction cooking zone, depending on the cookware size. The function can be activated only for a limited period of time.

Touch **P** to activate the function for the cooking zone.

The symbol turns red.

The function deactivates automatically.



For maximum duration values, refer to "Technical data".

5.6 OptiHeat Control (3 step Residual heat indicator)



WARNING!

 / = / - As long as the indicator is on, there is a risk of burns from residual heat.

The induction cooking zones produce the heat necessary for the cooking process directly in the bottom of the cookware. The glass ceramic is heated by the heat of the cookware.

The indicators  / = / - appear when a cooking zone is hot. They show the level of the residual heat for the cooking zones you are currently using.

The indicator may also appear:

- for the neighbouring cooking zones even if you are not using them,
- when hot cookware is placed on cold cooking zone,
- when the hob is deactivated but the cooking zone is still hot.

The indicator disappears when the cooking zone has cooled down.





5.7 Timer

Count Down Timer



Use this function to specify how long a cooking zone should operate during a single cooking session.





First set the heat setting, then set the function.



1. Touch  to activate the function or change the time.







The timer digits  and the indicators  and  come on the display.  turns red, and  turns white.

If the timer is not set, all indicators disappear after 4 seconds.

2. Touch  or  to set the time (00 - 99 minutes).

After 3 seconds, the timer starts to count down automatically. The indicators , , and  disappear.  stays red.

When the time comes to an end, a signal sounds and  flashes. To stop the signal, touch .



To deactivate the function: touch . The indicators  and  come on. Use  or  to set  on the display. Alternatively, set the heat level to 0. As a result, a signal sounds and the timer is cancelled.

CountUp Timer

You can use this function to monitor how long a cooking zone operates.

Touch  twice to activate the function.



The indicator  turns red, the timer starts to count up automatically.



To deactivate the function: touch . When the indicators light up, touch .





Minute Minder

You can use this function when the hob is activated but no cooking zone operates.



To see the control panel, place a pot on a cooking zone.







1. Touch , until the indicator  turns red, to activate the function.

2. Touch  or  to set the time.

The function starts automatically after 4 seconds. The indicators , , and  disappear.  stays red.

When you set the function, you can remove the pot.

When the time comes to an end, a signal sounds and   flashes. Touch  to stop the signal.

To deactivate the function: touch . The indicators  and  light up. Use  or  to set   on the display.

 The function has no effect on the operation of any cooking zone.

5.8 Lock

You can lock the control panel while the hob operates. It prevents an accidental change of the heat setting.

 You need to activate the function for each appliance separately.

Set the heat setting first.

Touch  to activate the function. The symbol turns red and blinks.

To deactivate the function, touch . The symbol turns white.

 When you deactivate the hob, you also deactivate this function.

5.9 Child Safety Device

This function prevents an accidental operation of the hob.

 You need to activate the function for each appliance separately.



Activate the hob first and do not set the heat setting.

Touch  until it turns red to activate the function.

The control bars disappear. Deactivate the hob.

 When you deactivate the hob, the function is still active.

To deactivate the function for only one

cooking time: Activate the hob with .  comes on. Touch  until it turns white. The control bars appear. Set the heat setting within 50 seconds. You can operate the hob.

When you deactivate the hob with  the function is still active.

To deactivate the function permanently:

Activate the hob and do not set the heat setting. Touch  until it turns white. The control bars appear. Deactivate the hob.

5.10 OffSound Control (Deactivating and activating the sounds)

Deactivate the hob first.





1. Touch  for 3 seconds to activate the function.

The display comes on and goes out.



2. Touch  for 3 seconds.

 or  comes on.

3. Touch  of the timer to choose one of the following:

-   - the sounds are off
-   - the sounds are on

4. Wait until the hob deactivates automatically to confirm your selection.

When the function is set to   you can hear the sounds only when:

- you touch 
- Minute Minder comes down
- Count Down Timer comes down
- you put something on the control panel.

6. HINTS AND TIPS



WARNING!

Refer to Safety chapters.

6.1 Cookware



Use the hob only with the original wok pan with a round bottom.



WARNING!

Do not use cookware with flat bottoms. Safe operation in accordance with EN60335 can only be guaranteed with the wok pan supplied with the hob.



For induction cooking zones a strong electro-magnetic field creates the heat in the cookware very quickly. Use the induction cooking zones with suitable cookware.

Cookware material

- **correct:** cast iron, steel, enamelled steel, stainless steel, the bottom made of multi-layer (with correct mark from a manufacturer).
- **not correct:** aluminium, copper, brass, glass, ceramic, porcelain.

Cookware is suitable for an induction hob if:

- water boils very quickly on a zone set to the highest heat setting.
- a magnet pulls on to the bottom of the cookware.

6.2 The noises during operation

If you can hear:

- crack noise: cookware is made of different materials (a sandwich construction).
- whistle sound: you use a cooking zone with a high power level and the cookware is made of different materials (a sandwich construction).
- humming: you use a high power level.
- clicking: electric switching occurs.
- hissing, buzzing: the fan operates.

The noises are normal and do not indicate any malfunction.

6.3 Energy saving

- If it is possible, always put the lids on the cookware.
- Put cookware on a cooking zone before you start it.
- Use the residual heat to keep the food warm or to melt it.

6.4 Öko Timer (Eco Timer)

To save energy, the heater of the cooking zone deactivates before the count down timer sounds. The difference in the operation time depends on the heat setting level and the length of the cooking operation.

6.5 Examples of cooking applications

The correlation between the heat setting of a zone and its consumption of power is not linear. When you increase the heat setting, it is not proportional to the increase of the consumption of power. It means that a cooking zone with the medium heat setting uses less than a half of its power.



The data in the table is for guidance only.

Heat setting	Use to:	Time (min)	Hints
1	Keep cooked food warm.	as necessary	Put a lid on the cookware.

Heat setting	Use to:	Time (min)	Hints
1 - 2	Hollandaise sauce, melt: butter, chocolate, gelatine.	5 - 25	Mix from time to time.
1 - 2	Solidify: fluffy omelettes, baked eggs.	10 - 40	Cook with a lid on.
2 - 3	Simmer rice and milkbased dishes, heat up ready-cooked meals.	25 - 50	Add at least twice as much liquid as rice, mix milk dishes halfway through the procedure.
3 - 4	Steam vegetables, fish, meat.	20 - 45	Add a couple of tablespoons of liquid.
4 - 5	Steam potatoes.	20 - 60	Use max. ¼ l of water for 750 g of potatoes.
4 - 5	Cook larger quantities of food, stews and soups.	60 - 150	Up to 3 l of liquid plus ingredients.
6 - 7	Gentle fry: escalope, veal cordon bleu, cutlets, rissoles, sausages, liver, roux, eggs, pancakes, doughnuts.	as necessary	Turn halfway through.
7 - 8	Heavy fry, hash browns, loin steaks, steaks.	5 - 15	Turn halfway through.
9	Boil water, cook pasta, sear meat (goulash, pot roast), deep-fry chips.		
P	Boil large quantities of water. PowerBoost is activated.		

6.6 Cooking with the wok

The induction wok is best for preparing "a la minute" dishes, in particular Chinese specialities. The food is continuously turned during the short frying time. Induction heating system allows you to cook very quickly and at high heat level. As a result meat and fish stay succulent and vegetables keep their colour, taste and vitamins.

At the heat setting 9 and above the induction wok has a high power with very fast reaction time. Fat and oil become too hot very quickly. When it starts to smoke, it is too hot. PowerBoost must be used only for a short time if you cook with small quantity of food or oil. There is the risk of damage to the wok pan.

The frying temperature can be estimated by testing with a wooden spoon. Hold the handle of a wooden spoon in the hot fat. If small bubbles rise to the surface, the frying temperature has been reached. If there are no bubbles, the frying temperature has not yet been reached.

Cooking methods

Stir-frying

- Swirl the wok with oil.
- Cut the ingredients into small pieces. Add sauces and seasonings and quickly fry over a high heat while stirring continuously.
- The cooking time is very short. Make sure that the ingredients are prepared before you start cooking.
- Start with the ingredients with the longest cooking time.
- Stir-frying is a very healthy cooking method.
- Vegetables keep their taste and colour, and stay nice and crunchy.
- Small pieces of meat stay tender.

Deep-frying

- The wok provides a very small drop in temperature and low oil consumption.
- Because of the constant temperature the fried food does not absorb much fat.
- Meat, fish, potatoes, vegetables, etc. keep an even colour and crust, and thus also the usual taste.

- Only use fats that are specially intended for deep-frying.

Poaching / Whipping

- The curved shape of the wok is suitable for whipping up custards, sabayons, butter sauces, fatless sponge or parfait mixtures without a bain marie at 65° C to 80° C.

Simmering

- Boiling: to cook food (for example spaghetti) at the boiling point.
- Simmering: to cook food (for example dumplings) just under the boiling point.

Stewing

- Cook the food in its own juice, or add of a little fat and other liquid.
- Use this method to cook food with a high water content (such as vegetables, fish and fruit) with a lid on over moderate heat, to keep the flavour.

Steaming

- This is a gentle cooking method, which keeps a high level of the food's nutrient content and colour.

Use of the fats and oils

When the temperature is too high, the fat begins to produce smoke. This temperature is called the smoke point.

Fat / Oil	Max. temperature °C	Smoke point °C
Butter	130	150
Pork fat	170	200
Beef fat	180	210
Olive oil	180	200
Sunflower oil	200	220
Peanut oil	200	235
Coconut oil	200	240

Use PowerBoost to heat up large quantities of water.

7. CARE AND CLEANING



WARNING!

Refer to Safety chapters.

7.1 General information

- Clean the hob after each use.
- Always use cookware with a clean base.
- Scratches or dark stains on the surface have no effect on how the hob operates.
- Use a special cleaner suitable for the surface of the hob.
- Use a special scraper for the glass.

7.2 Cleaning the hob

- **Remove immediately:** melted plastic, plastic foil, sugar and food with sugar, otherwise, the dirt can cause damage to the hob. Take care to avoid burns. Use a special hob scraper on the glass surface at an acute angle and move the blade on the surface.

- **Remove when the hob is sufficiently cool:** limescale rings, water rings, fat stains, shiny metallic discoloration. Clean the hob with a moist cloth and a non-abrasive detergent. After cleaning, wipe the hob dry with a soft cloth.
- **Remove shiny metallic discoloration:** use a solution of water with vinegar and clean the glass surface with a cloth.

7.3 Cleaning the wok pan

- Clean the wok pan inside and out with washing up liquid after each use.
- Soften heavy deposits with hot water. Clean the wok pan with a chromium steel cleaner and a sponge.
- You can remove blue discolourations, limescale stains or protein stains with vinegar or lime juice.



8. TROUBLESHOOTING



WARNING!

Refer to Safety chapters.

8.1 What to do if...

Problem	Possible cause	Remedy
You cannot activate or operate the hob.	The hob is not connected to an electrical supply or it is connected incorrectly.	Check if the hob is correctly connected to the electrical supply.
	The fuse is blown.	Make sure that the fuse is the cause of the malfunction. If the fuse is blown again and again, contact a qualified electrician.
	You touched 2 or more sensor fields at the same time.	Touch only one sensor field.
You can hear a constant beep noise.	There is water or fat stains on the control panel.	Clean the control panel.
	The electrical connection is incorrect.	Disconnect the hob from the electrical supply. Ask a qualified electrician to check the installation.
	An acoustic signal sounds and the hob deactivates. An acoustic signal sounds when the hob is deactivated.	Remove the object from the sensor fields.
The hob deactivates.	You put something on the sensor field  .	Remove the object from the sensor field.
Residual heat indicator does not come on.	The zone is not hot because it operated only for a short time or the sensor is damaged.	If the zone operated sufficiently long to be hot, speak to an Authorised Service Centre.
There is no sound when you touch the panel sensor fields.	The sounds are deactivated.	Activate the sounds. Refer to "Daily use".
 comes on.	Child Safety Device or Lock operates.	Refer to "Daily use".
The control bar blinks.	There is no cookware on the zone or the zone is not fully covered.	Put cookware on the zone so that it fully covers the cooking zone.
	The cookware is unsuitable.	Use cookware suitable for induction hobs. Refer to "Hints and tips".
	The diameter of the bottom of the cookware is too small for the zone.	Use cookware with correct dimensions. Refer to "Technical data".

Problem	Possible cause	Remedy
E and a number come on.	There is an error in the hob.	Deactivate the hob and activate it again after 30 seconds. If E comes on again, disconnect the hob from the electrical supply. After 30 seconds, connect the hob again. If the problem continues, speak to an Authorised Service Centre.

8.2 If you cannot find a solution...

If you cannot find a solution to the problem yourself, contact your dealer or an Authorised Service Centre. Give the data from the rating plate. Make sure, you operated the hob correctly. If not the

servicing by a service technician or dealer will not be free of charge, also during the warranty period. The information about guarantee period and Authorised Service Centres are in the guarantee booklet.

9. TECHNICAL DATA

9.1 Rating plate

Model IWE41600KB
 Typ 61 A1A 81 AD
 Induction 3.2 kW
 Ser.Nr.
 AEG

PNC 949 597 553 00
 220 - 240 V 50 - 60 Hz
 Made in Germany
 3.2 kW

9.2 Cooking zone specification

Nominal power (maximum heat setting) [W]	PowerBoost [W]	PowerBoost maximum duration [min]	Cooking zone diameter [mm]
2300	3200	5	300

10. ENVIRONMENTAL CONCERNS

Recycle materials with the symbol . Put the packaging in relevant containers to recycle it. Help protect the environment and human health by recycling waste of electrical and electronic appliances. Do not dispose of

appliances marked with the symbol  with the household waste. Return the product to your local recycling facility or contact your municipal office.

A series of 20 horizontal dotted lines for writing.

www.aeg.com/shop



867357208-D-392021



AEG