

USER MANUAL

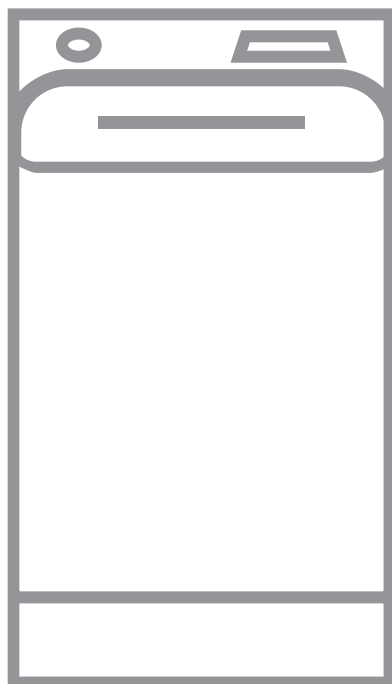

CONTENTS

1. SAFETY INFORMATION.....	2
2. SAFETY INSTRUCTIONS.....	4
3. PRODUCT DESCRIPTION.....	6
4. CONTROL PANEL.....	6
5. PROGRAMME CHART.....	8
6. CONSUMPTION VALUES.....	11
7. OPTIONS.....	12
8. SETTINGS.....	14
9. BEFORE FIRST USE.....	14
10. DAILY USE.....	14
11. HINTS AND TIPS.....	18
12. CARE AND CLEANING.....	19
13. TROUBLESHOOTING.....	22
14. TECHNICAL DATA.....	24

FOR PERFECT RESULTS

Thank you for choosing this AEG product. We have created it to give you impeccable performance for many years, with innovative technologies that help make life simpler features you might not find on ordinary appliances. Please spend a few minutes reading to get the very best from it.

Visit our website for:



Get usage advice, brochures, trouble shooter, service information:

www.aeg.com/webselfservice



Register your product for better service:

www.registeraeg.com



Buy Accessories, Consumables and Original spare parts for your appliance:

www.aeg.com/shop

CUSTOMER CARE AND SERVICE

Always use original spare parts.

When contacting our Authorised Service Centre, ensure that you have the following data available: Model, PNC, Serial Number.

The information can be found on the rating plate.

 Warning / Caution-Safety information

 General information and tips

 Environmental information

Subject to change without notice.

1. SAFETY INFORMATION

Before the installation and use of the appliance, carefully read the supplied instructions. The

manufacturer is not responsible for any injuries or damages that are the result of incorrect installation or usage. Always keep the instructions in a safe and accessible location for future reference.

1.1 Children and vulnerable people safety

- This appliance can be used by children aged from 8 years and above and persons with reduced physical, sensory or mental capabilities or lack of experience and knowledge if they have been given supervision or instruction concerning the use of the appliance in a safe way and understand the hazards involved.
- Children between 3 and 8 years of age and persons with very extensive and complex disabilities shall be kept away unless continuously supervised.
- Children of less than 3 years of age should be kept away unless continuously supervised.
- Do not let children play with the appliance.
- Keep all packaging away from children and dispose of it appropriately.
- Keep detergents away from children.
- Keep children and pets away from the appliance when the door is open.
- If the appliance has a child safety device, it should be activated.
- Children shall not carry out cleaning and user maintenance of the appliance without supervision.

1.2 General Safety

- Do not change the specification of this appliance.
- Do not exceed the maximum load of 6 kg (refer to the "Programme chart" chapter).
- The operating water pressure at the water entry point from the outlet connection must be between 0.5 bar (0.05 MPa) and 8 bar (0.8 MPa).
- The ventilation opening in the base must not be covered by a carpet, mat, or any floor covering.

- The appliance must be connected to the water mains using the new supplied hose sets, or other new hose sets supplied by the Authorised Service Centre.
- Old hose sets must not be reused.
- If the mains power supply cable is damaged, it must be replaced by the manufacturer, its Authorised Service Centre or similarly qualified persons to avoid an electrical hazard.
- Before any maintenance operation, deactivate the appliance and disconnect the mains plug from the socket.
- Do not use high pressure water sprays and/or steam to clean the appliance.
- Clean the appliance with a moist cloth. Use only neutral detergents. Do not use abrasive products, abrasive cleaning pads, solvents or metal objects.

2. SAFETY INSTRUCTIONS

2.1 Installation



The installation must comply with relevant national regulations.

- Remove all the packaging and the transit bolts including rubber bush with plastic spacer.
- Keep the transit bolts in a safe place. If the appliance is to be moved in the future they must be reattached to lock the drum to prevent an internal damage.
- Always take care when moving the appliance as it is heavy. Always use safety gloves and enclosed footwear.
- Do not install or use a damaged appliance.
- Follow the installation instructions supplied with the appliance.
- Do not install or use the appliance where the temperature can be less than 0°C or where it is exposed to the weather.
- The floor area on which the appliance is to be installed must be flat, stable, heat resistant and clean.
- Make sure that there is air circulation between the appliance and the floor.
- When the appliance is in its permanent position, check if it is levelled correctly with the aid of a spirit level. If it is not, adjust the feet accordingly.
- Do not install the appliance directly above a floor drain.
- Do not spray water on the appliance and do not expose it to excessive humidity.
- Do not install the appliance where the appliance lid cannot be fully opened.
- Do not put a closed container to collect possible water leakage under the appliance. Contact the Authorised Service Centre to ensure which accessories can be used.

2.2 Electrical connection



WARNING!

Risk of fire and electric shock.

- The appliance must be earthed.
- Always use a correctly installed shockproof socket.

- Make sure that the parameters on the rating plate are compatible with the electrical ratings of the mains power supply.
- Do not use multi-plug adapters and extension cables.
- Make sure not to cause damage to the mains plug and to the mains cable. Should the mains cable need to be replaced, this must be carried out by our Authorised Service Centre.
- Connect the mains plug to the mains socket only at the end of the installation. Make sure that there is access to the mains plug after the installation.
- Do not touch the mains cable or the mains plug with wet hands.
- Do not pull the mains cable to disconnect the appliance. Always pull the mains plug.
- This appliance complies with the E.E.C. Directives.
- This appliance is for household use only.
- Follow the safety instructions on the detergent packaging.
- Do not put flammable products or items that are wet with flammable products in, near or on the appliance.
- Make sure that all metal objects are removed from the laundry.
- Do not wash fabrics which are heavily soiled with oil, grease or other greasy substances. It can damage rubber parts of the washing machine. Prewash such fabrics by hand before loading them into the washing machine.

2.3 Water connection

- Do not cause damage to the water hoses.
- Before connection to new pipes, pipes not used for a long time, where repair work has been carried out or new devices fitted (water meters, etc.), let the water flow until it is clean and clear.
- Ensure that there are no visible water leaks during and after the first use of the appliance.
- Do not use an extension hose if the inlet hose is too short. Contact the service centre for the replacement of the inlet hose.
- You can extend the drain hose to maximum 400 cm. Contact the service centre for the other drain hose and the extension.

2.4 Use



WARNING!

Risk of injury, electric shock, fire, burns or damage to the appliance.

2.5 Service

- To repair the appliance contact an Authorised Service Centre.
- Use original spare parts only.

2.6 Disposal



WARNING!

Risk of injury or suffocation.

- Disconnect the appliance from the mains electrical and water supplies.
- Cut off the mains electrical cable close to the appliance and dispose of it.
- Remove the door catch to prevent children or pets from becoming trapped in the drum.
- Dispose of the appliance in accordance with local requirements for the disposal of Waste Electrical and Electronic Equipment (WEEE).

3. PRODUCT DESCRIPTION

3.1 Special features

Your new washing machine meets all modern requirements for an effective treatment of laundry with low water, energy and detergent consumption and respectful of fabric care.

3.2 Appliance overview

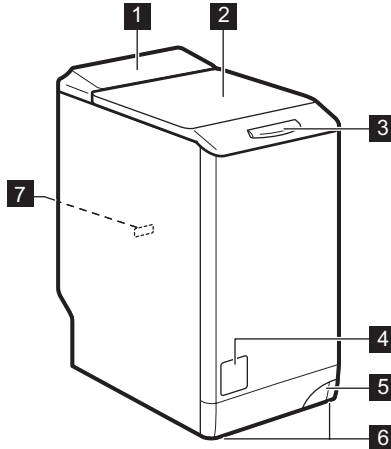

- The **ProSense technology** adjusts automatically the programme duration to the laundry in the drum to achieve perfect washing results in the minimum possible time.

- 1 Control panel
- 2 Lid
- 3 Lid handle
- 4 Drain pump filter
- 5 Lever to move the appliance
- 6 Feet for levelling the appliance
- 7 Rating plate

4. CONTROL PANEL

4.1 Control panel description

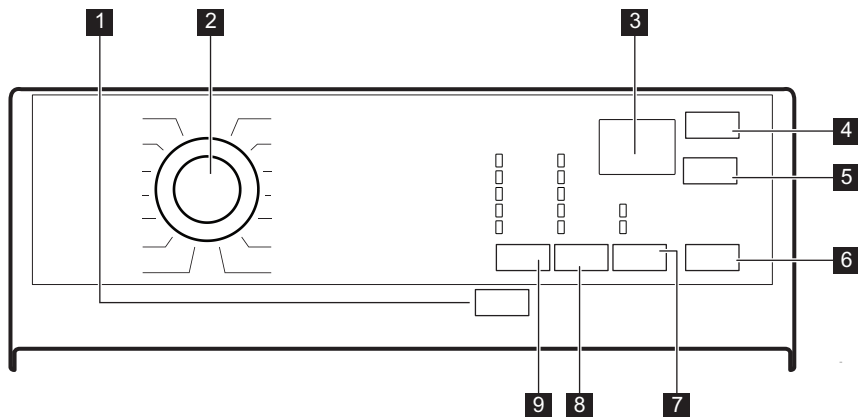

- | | |
|---|---|
| <p>1 Aan/Uit touch button</p> <p>2 Programme dial</p> <p>3 Display</p> <p>4 Startuitstel touch button</p> <p>5 Tijd Besparen touch button</p> <p>6 Start/Pauze touch button</p> | <p>7 Opties touch button</p> <ul style="list-style-type: none"> • Vlekken option • Voorwas option <p>8 TPM reduction touch button</p> <p>9 Temp. °C touch button</p> |
|---|---|

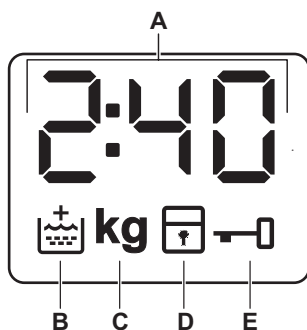

4.2 Display



A **0:00**



The digital indicator can show:

- Programme duration (e. g. **2:40**).
- Delay time (e. g. **30'** or **2h**).
- Cycle end (**U**).
- Warning code (**E20**).

B		Extra rinse indicator. It lights on when this option is selected.
C	kg	The kg indicator blink during the laundry load detections.
D		Child safety lock indicator.
E		Door locked indicator.

5. PROGRAMME CHART

Washing programmes

Programme	Default temperature Temperature range	Maximum spin speed Spin speed range	Maximum load	Programme description
Katoen	40 °C 95 °C - Cold	1200 rpm 1200-800 rpm	6 kg	White and coloured cotton heavily and normally soiled cotton items. White and coloured cotton
Katoen Eco 	40 °C 60 °C - 40°C	1200 rpm 1200-800 rpm	6 kg	White and coloured cotton heavily and normally soiled cotton items. Standard programmes for the Energy Label consumption values. According to regulation 1061/2010, the programme Katoen at 60 °C and the programme Katoen at 40 °C with the  option are respectively the «Standard 60°C cotton programme» and the «Standard 40°C cotton programme». They are the most efficient programmes in terms of combined energy and water consumption for washing normally soiled cotton laundry.  The water temperature of the washing phase may differ from the temperature declared for the selected programme.
Synthetica	40 °C 60 °C - Cold	1200 rpm 1200-800 rpm	3 kg	Synthetic items or mixed fabric items. Normal soil.
Strijkvrij	40 °C 60 °C - Cold	800 rpm 800-800 rpm	1 kg	Synthetic items requiring a gentle wash. Normal and light soil. ¹⁾

Programme	Default temperature Temperature range	Maximum spin speed Spin speed range	Maximum load	Programme description
Fijne Was	40 °C 40 °C - Cold	1200 rpm 1200-800 rpm	2,5 kg	Delicate fabrics such as acrylics, viscose and mixed fabrics requiring gentler washing. Normal soil.
 Wol/Zijde	40 °C 40 °C - Cold	1200 rpm 1200-800 rpm	1,5 kg	Machine washable wool, hand washable wool and other fabrics with «hand washing» care symbol ²⁾ .
Dekbed	40 °C 60 °C - Cold	800 rpm 800-800 rpm	2 kg	Single synthetic blanket, padded clothes, duvets, down jackets and similar items.
Pompen/ Centrif.	-	1200 rpm 1200-800 rpm	6 kg	To spin the laundry and to drain the water in the drum. All fabrics, except woollens and delicate fabrics.
Spoelen	-	1200 rpm 1200-800 rpm	6 kg	To rinse and spin the laundry. All fabrics, except woollens and very delicate fabrics. Reduce the spin speed accordingly to the type of laundry.
Snel Intensief	60 °C 60 °C - 40 °C	1200 rpm 1200-800 rpm	6 kg	Synthetic items. A cycle for outdoor sport clothes normal and heavily soil. The prewash phase is activated automatically to remove soil ³⁾ .
Jeans	40 °C 60 °C - Cold	1200 rpm 1200-800 rpm	3 kg	Denim clothing and jersey items. Normal soil. This programme performs a gentle rinsing phase, designed for denim, that reduces fading and does not cause washing powder residues on the fibres.
Katoen 20°	Cold	1200 rpm 1200-800 rpm	6 kg	Mixed fabric (cotton and synthetic items) ⁴⁾ .
Sport	30 °C 40 °C - Cold	1200 rpm 1200-800 rpm	2,5 kg	Mixed fabric sportswear like polyester, polyester, elastane blends, polyamide. A cycle for outdoor sport clothes normal soiled

	Katoen	Katoen Eco	Synthetica	Strijkvrij	Fijne Was	Wol/Zijde	Dekbed	Pompen/Centrif.	Spoelen	Snel Intensief	Jeans	Katoen 20°	Sport	20 min. - 3 kg
Extra Spoelen	■	■	■	■	■				■	■	■	■	■	

1) This option is not available with temperature lower than 40 °C.

2) If you set the shortest duration, we recommend that you decrease the load size. It is possible to fully load the appliance, however the washing results can be less satisfactory.

5.1 Woolmark Apparel Care - Blue



WOOL HAND WASH SAFE

The wool wash cycle of this machine has been approved by The Woolmark Company for the washing of wool garments labelled as «hand wash» provided that the garments are washed according to the instructions issued by the manufacturer of this washing machine. Follow the garment care label for drying and other laundry instructions. M1145





The Woolmark symbol is a Certification mark in many countries.

6. CONSUMPTION VALUES

i Stated values are obtained in laboratory conditions with relevant standards. Different causes can change the data: the quantity and type of laundry and ambient temperature. Water pressure, the supply voltage and the temperature of inlet water may also affect the washing programme duration.

i Technical specifications may be changed without prior notice to improve the quality of product.

i During the washing programme, the Prosense technology can vary the wash duration and the consumption values. For more details see 'The Prosense load detection' paragraph in 'Daily Use' chapter.

Programmes	Load (kg)	Energy consumption (kWh)	Water consumption (litre)	Approximate programme duration (minutes)	Remaining moisture (%) ¹⁾
Katoen 60°C	6	1,10	56	180	53
Katoen 40°C	6	0,65	54	150	53
Synthetica 40°C	3	0,45	46	105	35
Fijne Was 40°C	2,5	0,55	46	90	35
Wol/Zijde 30°C	1,5	0,35	50	65	30
Standard cotton programmes 					
Standard 60°C cotton 	6	0,80	47	246	53
Standard 60°C cotton 	3	0,54	38	174	53
Standard 40°C cotton 	3	0,49	39	175	53

¹⁾ At the end of spin phase.

Off Mode (W)	Left On Mode (W)
0.48	0.48
The information given in the chart above is compliant with the EU Commission regulation 1015/2010 implementing directive 2009/125/EC .	

7. OPTIONS

7.1 Aan/Uit

Pressing this button for a few seconds allows to activate or deactivate the appliance. Two different tunes sound while switching the appliance on or off.

As the Stand-by function automatically deactivates the appliance to decrease the energy consumption in a few cases, you may need to activate the appliance again.

For more details, refer to Stand-by paragraph in Daily Use chapter.

7.2 Introduction



The options/functions are not selectable with all washing programmes. Check the compatibility between options/functions and washing programmes in the "Programme Chart". An option/function can exclude another one, in this case the appliance doesn't allow you to set the incompatible options/functions together. Make sure the screen and touch buttons are always clean and dry.

7.3 Temp. °C

When you select a washing programme, the appliance automatically proposes a default temperature.

Set this option to change the default temperature.

The indicator  = cold water of the set temperature comes on (the appliance does not heat the water).

7.4 TPM

When you set a programme, the appliance automatically sets the maximum spin speed allowed.

Touch repeatedly this button to:

Decrease the spin speed

Activate the Spoelstop option

- Set this option to prevent the laundry creases.
- The related indicator comes on.
- There is a water in the drum when the programme is completed.
- The door stays locked and the drum turns regularly to reduce creasing.
- You must drain the water to unlock the lid.
- If you touch the Start/Pauze button, the appliance performs the spinning phase and drains the water.

 The appliance empties the water out automatically after 18 hours approximately.

Activate the No Spin option 

- Set this option to deactivate all spin phases. Only the drain phase is available.
- The related indicator comes on.
- Set this option for very delicate fabrics.
- The rinses phase uses more water for some washing programmes.

 The spin speed can be reduce.

7.5 Opties

Press this button repeatedly to activate one of the available options.

• Vlekken

Select this option to add an anti-stain phase to a programme in order to treat heavily soiled or stained laundry with stain remover.

Pour the stain remover into  compartment. The stain remover will be added in the appropriate phase of the washing programme.

 This option can increase the programme duration. This option is not available with a temperature lower than 40 °C.

• Voorwas

Use this option to add a prewash phase at 30 °C before the washing phase.

This option is recommended for heavily soiled laundry, especially if containing sand, dust, mud and other solid particles.

 This option can increase the programme duration.

The relevant indicator comes on.

7.6 Tijd Besparen

This option may be advisable to shorten the washing programme.

Use this option for items with normal or light soil or items to refresh.

Touch this button **once** to decrease the duration.

In case of smaller load, touch this button **twice** to set an extra quick programme.

The indicator of the option and the indicator of the set value are on.

7.7 Startuitstel

With this option you can delay the start of a programme in a more convenient time.

Touch repeatedly the button to set the required delay. The time increases by steps of 30 minutes up to 90' and from 2 hours up to 20 h.

The indicator of the option and the indicator of the set value are on. After

touching the Start/Pauze button the appliance begins the countdown.

8. SETTINGS

8.1 Acoustic signals

To deactivate the acoustic signals when the programme is completed touch the Startuitstel and the Tijd Besparen buttons simultaneously for about 6 seconds.



The acoustic signals, they continue operate when the appliance has a malfunction.

8.2 Child Lock

With this option you can prevent children from playing with the control panel.

- To **activate/deactivate** this option, touch the TPM and the Opties buttons simultaneously until the indicator  **comes on/goes off** on the display.

9. BEFORE FIRST USE

1. Connect the mains plug to the mains socket.
2. Open the water tap.
3. Put 2 litre of water in the detergent compartment for washing phase.

This activates the drain system.

4. Put a small quantity of detergent in the compartment for washing phase.

10. DAILY USE

10.1 Loading the laundry

1. Open the appliance lid.

7.8 Start/Pauze

Touch the Start/Pauze button to start, pause the appliance or interrupt a running programme.

You can activate this option:

- After you touch the Start/Pauze button: all the buttons and the programme dial are deactivated (except Aan/Uit button).
- Before you touch the Start/Pauze button: the appliance cannot start.

The appliance keeps the selection of this option after you switch it off.

8.3 Permanent Extra Rinse

With this option you can permanently have an extra rinse when you set a new programme.

- To **activate/deactivate** this option touch the Temp. °C button and the TPM button simultaneously until relevant indicator  **comes on/goes off** on display.

5. Set and start a programme for cotton at the highest temperature without laundry.

This removes all possible dirt from the drum and the tub.

2. Push the button **A**.

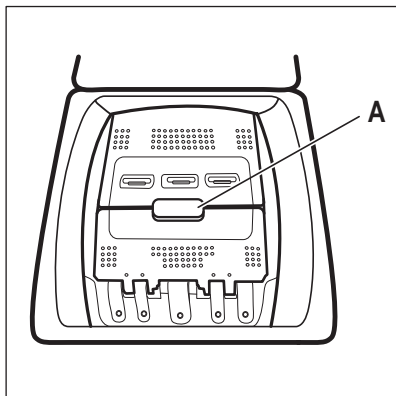

The drum opens automatically.

3. Put the laundry in the drum, one item at a time.
4. Shake the items before you put them in the appliance.

Make sure not to put too much laundry in the drum.

5. Close the drum and the lid.



CAUTION!

Before you close the lid of your appliance, make sure that you close the drum correctly.

10.2 Detergent compartments. Using detergent and additives

1. Measure out specified detergents for washing machine the detergent and the fabric conditioner.
2. Put the detergent and the fabric conditioner into the proper compartments.



Always obey the instructions that you find on the packaging of the detergent products.

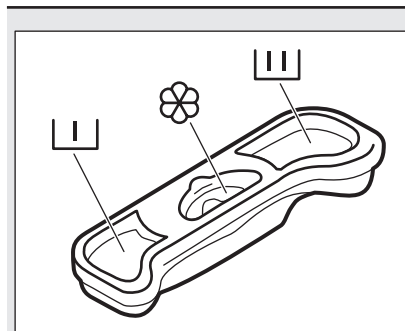

Detergent compartment for pre-wash phase.

When you set a programme with a stain, add detergent (powder or liquid).



Detergent compartment for washing phase.



Compartment for liquid additives (fabric conditioner, starch).

The mark **M** is the maximum level for the quantity liquid additives.

10.3 Activating the appliance

1. Connect the mains plug to the mains socket.
2. Open the water tap.
3. Press button Aan/Uit to activate the appliance.

A short tune sounds.

- The indicator of Start/Pauze flashes.
 - The display shows the programme duration.
2. If necessary, change the temperature, the spin speed, the cycle duration, or add available options. When you activate an option, the indicator of the set option comes on.

10.4 Setting a programme

1. Turn the programme knob and set the programme:



In case a selection is **not possible**, no indicator comes on and an acoustic signal sounds.

10.5 Starting a programme with the delay start

Touch the Start/Pauze button.

The appliance starts the countdown of the delay start.

When the countdown is completed, the programme starts.

-  The PROSENSE adapts starts at the end of the countdown.

10.6 Starting a programme

To cancel the delay start:

1. Touch the Start/Pauze button to pause the appliance. The related indicator flashes.
2. Touch the Startuitstel button repeatedly until the display shows .
3. Touch the Start/Pauze button again to start the programme immediately.

10.7 Cycle time recalculation

-  After approximately 15 minutes from the start of the programme:

- The appliance adjusts automatically the cycle time to the laundry you have put in the drum to have perfect washing results in the minimum necessary time.
- The display shows the new time value.

10.8 Interrupting a programme and changing a option

To change the delay start:

1. Touch the Start/Pauze button to pause the appliance. The related indicator flashes.
2. Touch the Startuitstel button repeatedly until the display shows the desired delay time.
3. Touch the Start/Pauze button again to start the new countdown.

10.9 Cancelling a running programme

Touch the Start/Pauze button to start the programme.

The related indicator stops flashing and stays on.

The programme starts, the lid is locked.

The display shows the indicator .

-  The drain pump can operate shortly before the appliance fills water.

10.10 The ProSense load detection

You can change only some options before they operate.

1. Press button Start/Pauze. The related indicator flashes.
2. Change the option set.
3. Press the button Start/Pauze again. The programme continues.

10.9 Cancelling a running programme

1. Press the button Aan/Uit to cancel the programme and to deactivate the appliance.
2. Press the button Aan/Uit again to activate the appliance.

Now, you can set a new washing programme.

-  If the ProSense phase is already carried out and the water filling is already started, the new programme starts **without repeating the ProSense phase**. The water and the detergent are not drained out in order to avoid waste.

10.10 The ProSense load detection

After touching the Start/Pauze button:

1. The ProSense starts the laundry load detection to calculate the real

programme duration. The indicator **kg** and the time dots **■** flash.

- After about 15 minutes the display shows the new programme duration: the indicator **kg** goes off and the time dots **■** stops flashing. The appliance adjusts automatically the programme duration to the load to achieve perfect washing results in the minimum possible time. The programme duration could increase or decrease.

 The ProSense detection is carried out with complete washing programmes only (no skipping phase selected).

10.11 Opening the Lid when the programme operates



CAUTION!

If the temperature and level of the water in the drum are too high, the  indicator stays on and you cannot open the lid.

To open the lid proceed as follows:

- Press the button Aan/Uit for some seconds to deactivate the appliance.
- Wait for some minutes and then open carefully the lid.
- Close the lid.
- Activate the appliance and set the programme again.

10.12 Opening the Lid when the delay start is active

While the delay start operates, the appliance lid is locked.

To open the appliance lid:

- Press button Start/Pauze. The  indicator goes off.
- Open the appliance lid.
- Close the lid and press button Start/Pauze.

The delay start continues.

10.13 End of cycle

When the programme has finished, the appliance stops automatically. The acoustic signal operates (if it is active).

In the display  comes on and the lid locked indicator  goes off.

The indicator of Start/Pauze button goes off.

- Press button Aan/Uit to deactivate the appliance.

After five minutes from the end of the programme, the energy saving function automatically deactivates the appliance.



When you activate the appliance again, the display show the end of the last set programme. Turn the programme knob to set a new cycle.

- Remove the laundry from the appliance.
- Make sure that the drum is empty.
- Keep the door ajar, to prevent mildew and odours

10.14 Draining water out after end of cycle

The washing programme is completed, but there is water in the drum:

The drum turns regularly to prevent the creases in the laundry.

The lid lock indicator  is on. The lid stays locked.

You must drain the water to open the lid:

- If necessary, decrease the spin speed.
- Press the Start/Pauze button. The appliance drains the water and spins.
- When the programme is completed and the door lock indicator  goes off, you can open the door .
- Press Aan/Uit some seconds to deactivate the appliance.



The appliance drains and spins automatically after approximately 18 hours.

10.15 AUTO Stand-by option

The AUTO Stand-by function automatically deactivates the appliance to decrease the energy consumption when:

- You do not use the appliance for 5 minutes before you press Start/Pauze button.
Press the button Aan/Uit to activate the appliance again.
- After 5 minutes from the end of the washing programme
Press the button Aan/Uit to activate the appliance again.

The display shows the end of the last set programme.

Turn the programme knob to set a new cycle.



If you set a programme or an option that ends with water in the drum, the **AUTO Stand-by function doesn't deactivate** the appliance to remind you to drain the water.

11. HINTS AND TIPS



WARNING!

Refer to Safety chapters.

11.1 The laundry load

- Divide the laundry in: white, coloured, synthetics, delicates and wool.
- Obey the washing instructions that are on the laundry care labels.
- Do not wash white and coloured items together.
- Some coloured items can discolour with the first wash. We recommend that you wash them separately for the first times.
- Button up pillowcases, close zippers, hooks and poppers. Tie up belts.
- Empty the pockets and unfold the items.
- Turn multilayered fabrics, wool and items with painted illustrations inside out.
- Remove hard stains with a special detergent.
- Wash and pre-treat heavy soil stains before putting items in drum
- Be careful with the curtains. Remove the hooks and put the curtains in a washing bag or pillowcase.
- Do not wash laundry without hems or with cuts. Use a washing bag to wash small and/or delicate items (e.g. underwired bras, belts, tights, etc.).
- A very small load can cause balance problems with the spin phase. If this occurs, adjust manually the items in

the tub and start the spin phase again.

11.2 Stubborn stains

For some stains, water and detergent is not sufficient.

We recommend that you pre-treat these stains before you put the items in the appliance.

Special stain removers are available. Use the special stain remover that is applicable to the type of stain and fabric.

11.3 Detergents and additives

- Only use detergents and additives specially made for washing machines:
 - powder detergents for all types of fabric,
 - powder detergents for delicate fabrics (40 °C max) and woollens,
 - liquid detergents, preferably for low temperature wash programmes (60 °C max) for all types of fabric, or special for woollens only.
- Do not mix different types of detergents.
- To help the environment, do not use more than the correct quantity of detergent.
- Obey the instructions that you find on the on packaging of these products.
- Use the correct products for the type and colour of the fabric, the

programme temperature and the level of soil.

- If your appliance does not have the detergent dispenser with the flap device, add the liquid detergents with a dosing ball (supplied by the detergent's manufacturer).

11.4 Ecological hints

- Set a programme without the prewash phase to wash laundry with normal soil.
- Always start a washing programme with the maximum load of laundry allowed.
- If necessary, use a stain remover when you set a programme with a low temperature.

12. CARE AND CLEANING



WARNING!

Refer to Safety chapters.

12.1 External cleaning

Clean the appliance with soap and warm water only. Fully dry all the surfaces.



CAUTION!

Do not use alcohol, solvents or chemical products.

12.2 Descaling

If the water hardness in your area is high or moderate, we recommend that you use a water descaling product for washing machines.

Regularly examine the drum to prevent limescale and rust particles.

- To use the correct quantity of detergent, check the water hardness of your domestic system. Refer to "Water hardness".

11.5 Water hardness

If the water hardness in your area is high or moderate, we recommend that you use a water softener for washing machines. In areas where the water hardness is soft it is not necessary to use a water softener.

To know the water hardness in your area, contact your local water authority.

Use the correct quantity of the water softener. Obey the instructions that you find on the packaging of the product.

To remove rust particles use only special products for washing machines. Do this separately from the laundry wash.



Always obey the instructions that you find on the packaging of the product.

12.3 Maintenance wash

With the low temperature programmes it is possible that some detergent stays in the drum. Perform a maintenance wash regularly. To do this:

- Remove all laundry from the drum.
- Select the cotton programme with the highest temperature with a small quantity of detergent.

12.4 Cleaning the detergent dispenser

1.

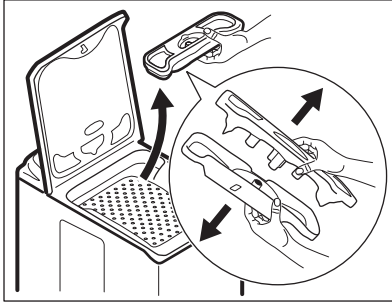

2.

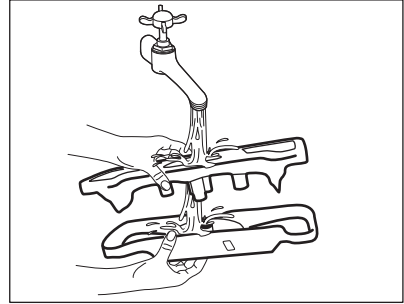

3.

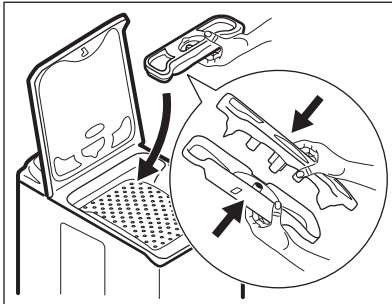

12.5 Cleaning the drain filter



Do not clean the drain filter if the water in the appliance is hot.

1.

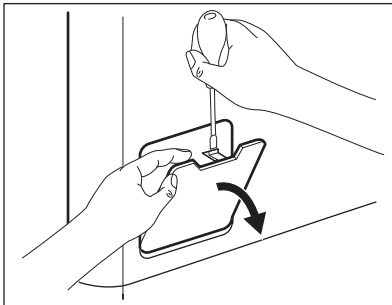

2.

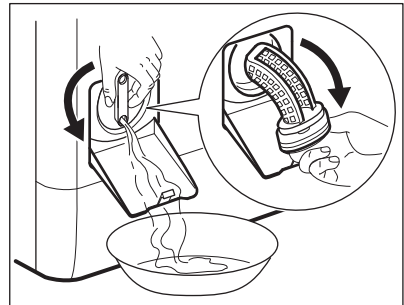

3.

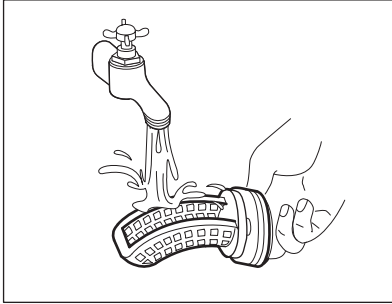

4.

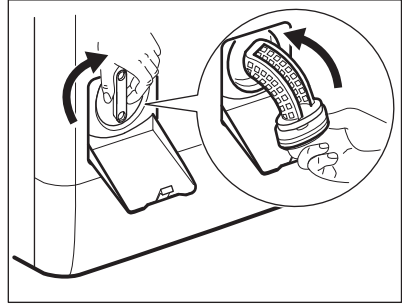

5.

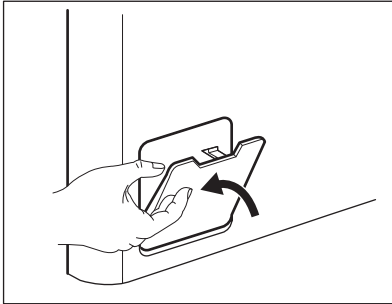

12.6 Cleaning the inlet hose and the valve filter

1.

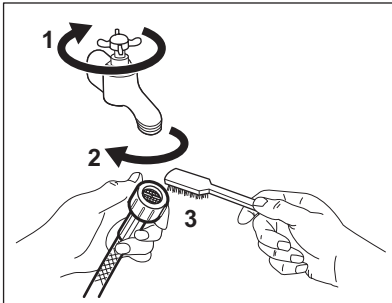

2.

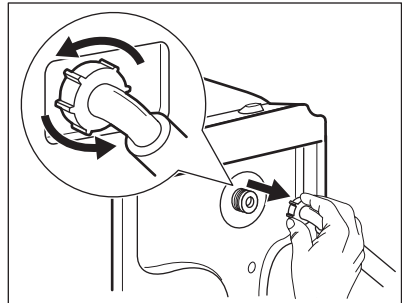

3.

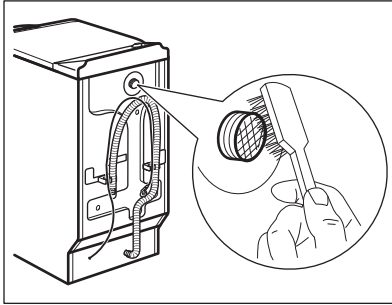

12.7 Emergency drain

Because of a malfunction, the appliance cannot drain the water.

If this occurs, do steps (1) through (5) of 'Cleaning the drain filter'. If necessary, clean the pump.

12.8 Frost precautions

If the appliance is installed in an area where the temperature can be less than 0° C, remove the remaining water from the inlet hose and the drain pump.

1. Disconnect the mains plug from the mains socket.

4.

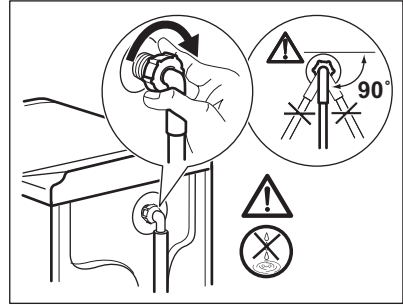

2. Close the water tap.
3. Put the two ends of the inlet hose in a container and let the water flow out of the hose.
4. Empty the drain pump. Refer to the emergency drain procedure.
5. When the drain pump is empty, install the inlet hose again.



WARNING!

Make sure that the temperature is higher than 0 °C before you use the appliance again.

The manufacturer is not responsible for damages caused by low temperatures.

13. TROUBLESHOOTING



WARNING!

Refer to Safety chapters.

13.1 Introduction

The appliance does not start or it stops during operation.

First try to find a solution to the problem (refer to the table). If the problem persists, contact the Authorised Service Centre.

With some problems, the acoustic signals operate and the display shows an alarm code:

- **E10** - The appliance does not fill with water properly. Start the appliance again by pressing Start/Pauze button.

After 10 seconds the lid will be unlocked.

- **E20** - The appliance does not drain the water.
- **E40** - The appliance lid is open or not closed correctly. Please check the lid!
- **E40** - The mains supply is unstable. Wait until the mains supply is stable.
- **EFO** - The anti-flood device is on. Disconnect the appliance and close the water tap. Contact the Authorised Service Centre.



WARNING!

Deactivate the appliance before you do the checks.

13.2 Possible failures

Problem	Possible solution
The programme does not start.	<ul style="list-style-type: none"> • Make sure that the mains plug is connected to the mains socket. • Make sure that the appliance lid and drum doors are closed properly. • Make sure that there is no damaged fuse in the fuse box. • Make sure that the Start/Pauze has been touched. • If the delay start is set, cancel the setting or wait for the end of countdown. • Deactivate the Child Lock function if it is on.
The appliance does not fill with water properly.	<ul style="list-style-type: none"> • Make sure that the water tap is open. • Make sure that the pressure of the water supply is not too low. For this information, contact your local water authority. • Make sure that the water tap is not clogged. • Make sure that the inlet hose has no kinks, damages or bends. • Make sure that the connection of the water inlet hose is correct. • Make sure that the filter of the inlet hose and the filter of the valve are not clogged. Refer to 'Care and cleaning'.
The appliance fills with water and drains immediately	<ul style="list-style-type: none"> • Make sure that the drain hose is in the correct position. The hose may be positioned too low. Refer to "Installation instruction".
The appliance does not drain the water.	<ul style="list-style-type: none"> • Make sure that the sink spigot is not clogged. • Make sure that the drain hose has no kinks or bends. • Make sure that the drain filter is not clogged. Clean the filter, if necessary. Refer to "Care and cleaning". • Make sure that the connection of the drain hose is correct. • Set the drain programme if you set a programme without drain phase. • Set the drain programme if you set an option which ends with water in the tub.
The spin phase does not operate or the washing cycle lasts longer than usual.	<ul style="list-style-type: none"> • Set the spin programme. • Make sure that the drain filter is not clogged. Clean the filter, if necessary. Refer to "Care and cleaning". • Adjust manually the items in the tub and start the spin phase again. This problem may be caused by balance problems.
There is water on the floor.	<ul style="list-style-type: none"> • Make sure that the couplings of the water hoses are tight and there is not water leakages. • Make sure that the water inlet hose and the drain hose have no damages. • Make sure you use the correct detergent and the correct quantity of it.

Problem	Possible solution
You cannot open the appliance lid	<ul style="list-style-type: none"> • Make sure that the washing programme is finished. • Set the drain or the spin option if there is water in the tub.
The appliance makes an unusual noise and vibrates.	<ul style="list-style-type: none"> • Make sure the levelling of the appliance is correct. Refer to "Installation instruction". • Make sure that the packaging and/or the transit bolts are removed. Refer to "Installation instruction". • Add more laundry in the drum. The load may be too small.
The programme duration increases or decreases during programme execution.	<ul style="list-style-type: none"> • The ProSense function is able to adjust the programme duration according to the type and the laundry load size. Refer to "The ProSense load detection" in "Daily Use" chapter.
The washing results are not satisfactory.	<ul style="list-style-type: none"> • Increase the detergent quantity or use a different detergent. • Use special products to remove the stubborn stains before you wash the laundry. • Make sure that you set the correct temperature. • Decrease the laundry load.
Too much foam in the drum during the washing cycle.	<ul style="list-style-type: none"> • Reduce the quantity of detergent.

After the check, activate the appliance. The programme continues from the point of interruption.

If the problem occurs again, contact the Authorised Service Centre.

If the display shows other alarm codes. Deactivate and activate the appliance. If the problem continues, contact the Authorised Service Centre.

14. TECHNICAL DATA

Dimension	Width/ Height/ Depth/ Total depth	400 mm/ 890 mm/ 600 mm/ 600 mm
Electrical connection	Voltage	230 V
	Overall power	2200 W
	Fuse	10 A
	Frequency	50 Hz
Level of protection against ingress of solid particles and moisture ensured by the protective cover, except where the low voltage equipment has no protection against moisture		IPX4
Water supply pressure	Minimum	0,5 bar (0,05 MPa)
	Maximum	8 bar (0,8 MPa)
Water supply ¹⁾		Cold water
Maximum Load	Cotton	6 kg

Energy Efficiency Class	A+++	
Spin Speed	Maximum	1200 rpm

1) Connect the water inlet hose to a water tap with a 3/4" thread.

15. ENVIRONMENTAL CONCERNS

Recycle materials with the symbol .
Put the packaging in relevant containers to recycle it. Help protect the environment and human health by recycling waste of electrical and electronic appliances. Do not dispose of

appliances marked with the symbol  with the household waste. Return the product to your local recycling facility or contact your municipal office.

www.aeg.com/shop



192936391-A-042018



AEG